

GUYED TOWERS

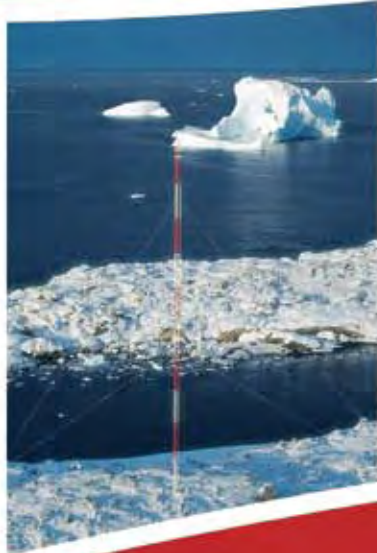

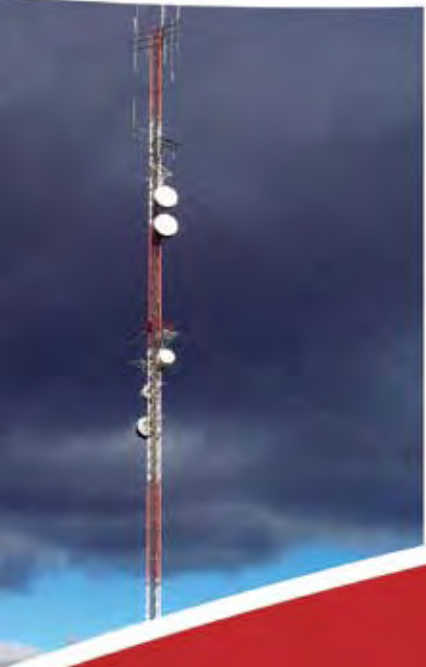

STANDARD 45GSR GUYED TOWER

ROHN 45GSR
The first. The original.

45GSR

GENERAL USE

The 45GSR maintains the utility of the 45G and adds the strength of solid round steel legs. The 45GSR has a strong 4 bolt flange connection, giving connection joints superior strength over typical 1 bolt flange connection systems. The 45GSR is available in heights up to 340'.

FEATURES

- Completely hot-dip galvanized after fabrication
- Built on a 16 3/4" equilateral triangle design
- Heavy solid steel round legs joined by Zig-Zag® cross members
- Each section contains all required nuts and bolts shipped with section
- Continuous solid round steel bracing

CAUTION

Mixing copies of ROHN towers with ROHN towers is dangerous and voids all engineering and warranty data supplied by ROHN. Materials used by others are not the same quality and have not been tested or engineered by ROHN. Mixing ROHN tower sections with non-ROHN products may cause tower failure or injury.

Per Rev G requirements, any structure greater than 10' requires a climber safety device. Please see page 92 for ordering information.





STANDARD 45GSR GUYED TOWER SECTIONS

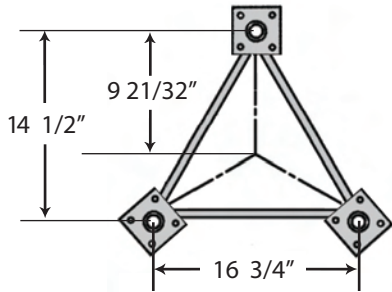

QUICK REFERENCE	
PARTS & ACCESSORIES	PAGE 92
GROUNDING INFORMATION	PAGE 93
FOUNDATION INFORMATION	PAGES 93-97

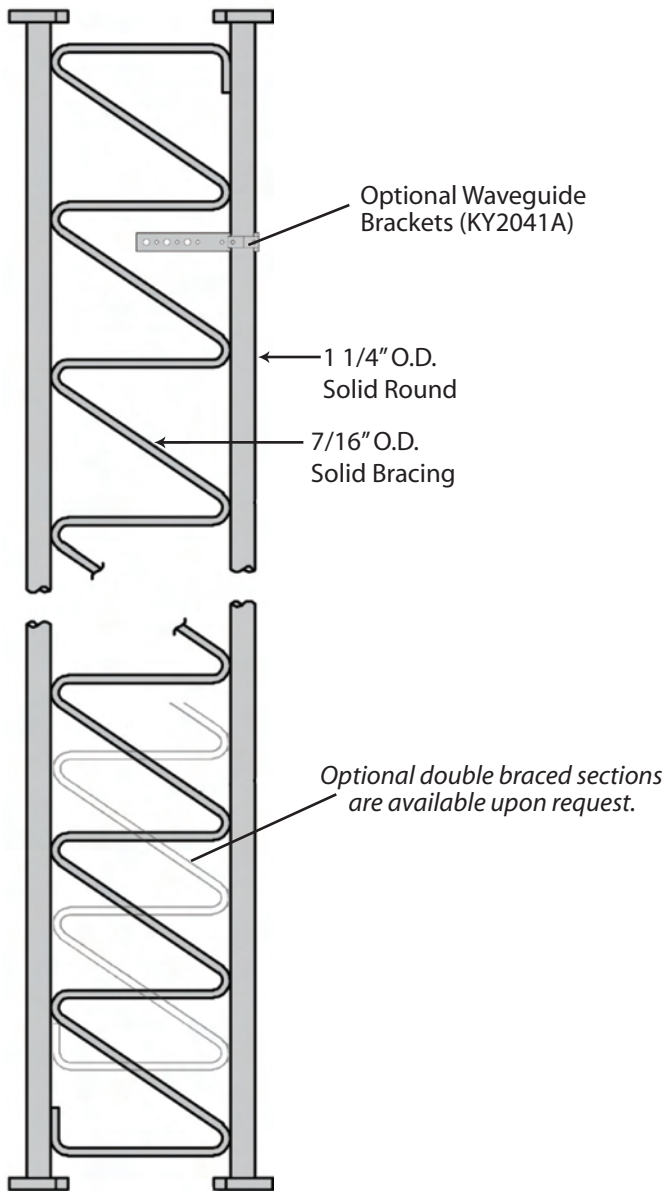

STANDARD SECTION
45GSR10 - 10' Section
45GSR20 - 20' Section

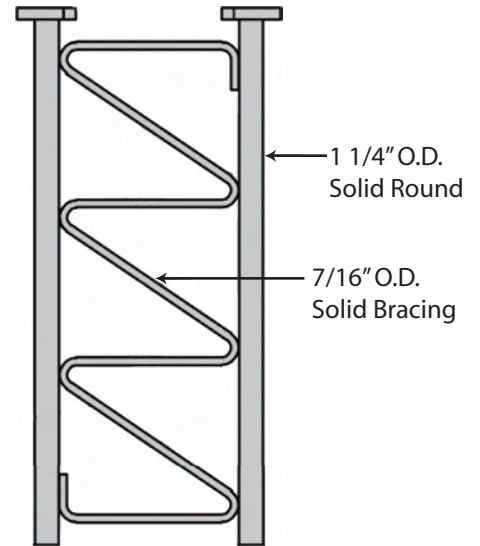

4.3' 45GSR SHORT BASE
45GSRSB

TO BE EMBEDDED IN CONCRETE.



BUYERS GUIDE STANDARD DESIGNS - 45GSR 90MPH REV. G [3 SECOND GUST]

Design Criteria

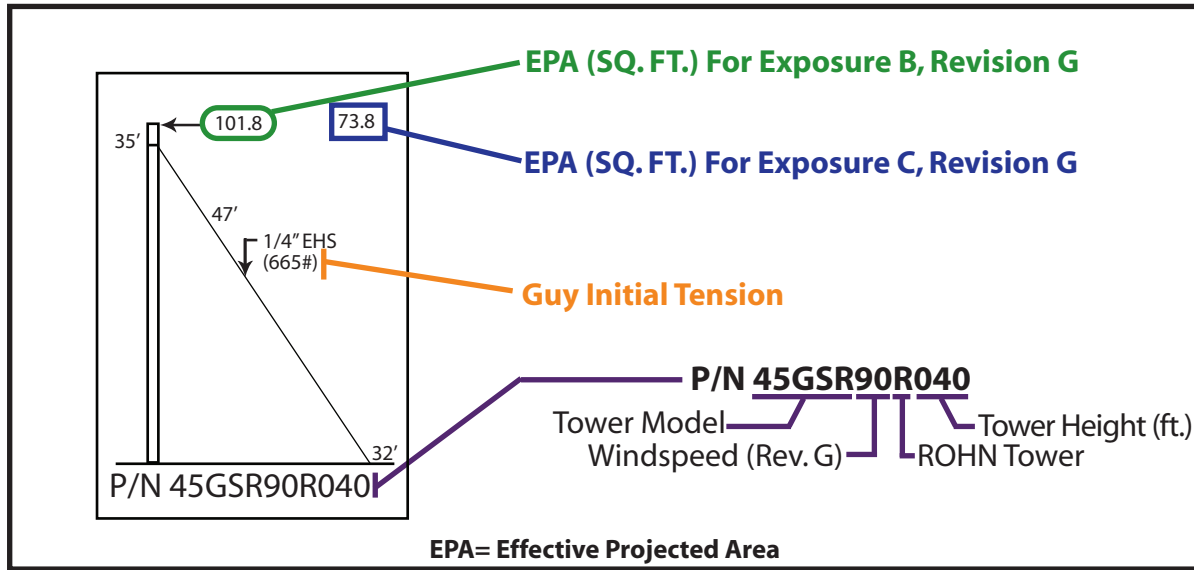

This document is to serve as a guide for sizing and purchasing the 45GSR tower. Tower and foundation installations should be performed by qualified and experienced personnel using assembly drawings provided with each tower.

DESIGN NOTES:

1. Tower designs are in accordance with ANSI/TIA-222-G, Class I Structures, Topographic Category 1.
2. Design assumes towers are installed on level ground. Lower EPA values will apply for roof mounted towers or for sites located on unusual terrain.
3. Designs assume two 7/8" diameter lines on each tower face.
4. Anchor radius is from tower base to intersection of anchor rod with ground.
5. Guy chord lengths shown are based on level ground. Initial tensions for guys are shown in () in pounds at 60° Fahrenheit.
6. Antenna and mounts are assumed symmetrically placed at the tower top.

PARTS LIST NOTES:

1. Items listed are required for complete guyed towers.
2. Base and anchor foundations listed refer to standard foundation designations.
3. Guys provided with each standard tower are based on level ground conditions with an additional 6% length.
4. Rev G anchor grounding (AGK1GGX) and base grounding (BGK3GGX) are included with the tower material.
5. Assembly drawings and a safety package (P/N: ACWS) are included with each tower.
6. Parts lists are subject to change based on availability or revised design criteria.

FOR FOUNDATION INFORMATION, PLEASE SEE PAGES 93-97.

FOR GENERAL INSTALLATION INFORMATION, PLEASE SEE PAGES 147-153.



STANDARD DESIGN - 45GSR
90MPH REV. G

45GSR
SOLID ROD

40' ROHN 45GSR
All parts shown in table are included when ordering
Part No: 45GSR90R040

50' ROHN 45GSR
All parts shown in table are included when ordering
Part No: 45GSR90R050

60' ROHN 45GSR
All parts shown in table are included when ordering
Part No: 45GSR90R060

70' ROHN 45GSR
All parts shown in table are included when ordering
Part No: 45GSR90R070

80' ROHN 45GSR
All parts shown in table are included when ordering
Part No: 45GSR90R080

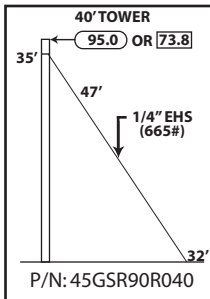

TOWER PARTS INCLUDED	45GSR20	45GSRSB	GA45GD	FDNS	
	2	1	1	BASE	ANCHOR
GUYS & CONNECTIONS INCLUDED	1/4EHS	BG2144	3/8THH	1/2TBE&J	TBSAFETY
	150'	6	6	3	3
ANCHORS & GROUNDING INCLUDED	GAC3455TOP	AGK1GGX	BGK3GGX	CPC.5/.75	
	3	1	3	3	

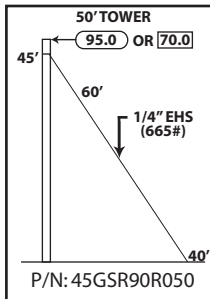

TOWER PARTS INCLUDED	45GSR20	45GSR10	45GSRSB	GA45GD	FDNS	
	2	1	1	1	FB1G	AB2
GUYS & CONNECTIONS INCLUDED	1/4EHS	BG2144	3/8THH	1/2TBE&J	TBSAFETY	
	200'	6	6	3	3	
ANCHORS & GROUNDING INCLUDED	GAC3455TOP	AGK1GGX	BGK3GGX	CPC.5/.75		
	3	1	3	3		

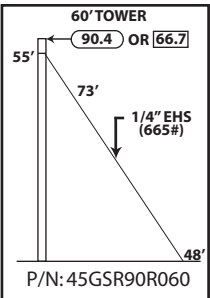

TOWER PARTS INCLUDED	45GSR20	45GSRSB	GA45GD	FDNS	
	3	1	1	FB1G	AB2
GUYS & CONNECTIONS INCLUDED	1/4EHS	BG2144	3/8THH	1/2TBE&J	TBSAFETY
	250'	6	6	3	3
ANCHORS & GROUNDING INCLUDED	GAC3455TOP	AGK1GGX	BGK3GGX	CPC.5/.75	
	3	1	3	3	

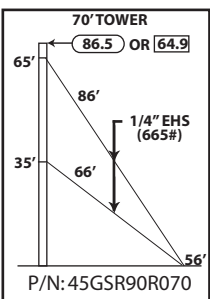

TOWER PARTS INCLUDED	45GSR20	45GSR10	45GSRSB	GA45GD	FDNS	
	3	1	1	2	FB1G	AB2
GUYS & CONNECTIONS INCLUDED	1/4EHS	BG2144	3/8THH	1/2TBE&J	TBSAFETY	
	500'	12	12	6	3	
ANCHORS & GROUNDING INCLUDED	GAC3455TOP	AGK1GGX	BGK3GGX	CPC.5/.75		
	3	1	3	3		

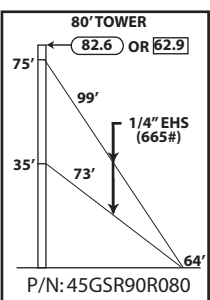

TOWER PARTS INCLUDED	45GSR20	45GSRSB	GA45GD	FDNS	
	4	1	2	FB1G	AB2
GUYS & CONNECTIONS INCLUDED	1/4EHS	BG2144	3/8THH	1/2TBE&J	TBSAFETY
	550'	12	12	6	3
ANCHORS & GROUNDING INCLUDED	GAC3455TOP	AGK1GGX	BGK3GGX	CPC.5/.75	
	3	1	3	3	



STANDARD DESIGN - 45GSR
90MPH REV. G

45GSR
SOLID ROD

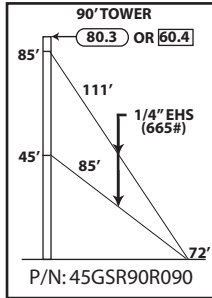

TOWER PARTS INCLUDED	45GSR20	45GSR10	45GSRSB	GA45GD	FDNS	
					BASE	ANCHOR
	4	1	1	2	FB1G	AB2
GUYS & CONNECTIONS INCLUDED	1/4EHS	BG2144	3/8THH	1/2TBE&J	TBSAFETY	
	625'	12	12	6	3	
ANCHORS & GROUNDING INCLUDED	GAC3455TOP	AGK1GGX	BGK3GGX	CPC.5/.75		
	3	1	3	3		

90' ROHN 45GSR
All parts shown in table are included when ordering
Part No: 45GSR90R090

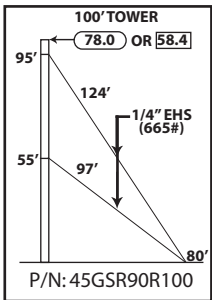

TOWER PARTS INCLUDED	45GSR20	45GSR10	45GSRSB	GA45GD	FDNS	
					BASE	ANCHOR
	5	1	1	2	FB1G	AB2
GUYS & CONNECTIONS INCLUDED	1/4EHS	BG2144	3/8THH	1/2TBE&J	TBSAFETY	
	725'	12	12	6	3	
ANCHORS & GROUNDING INCLUDED	GAC3455TOP	AGK1GGX	BGK3GGX	CPC.5/.75		
	3	1	3	3		

100' ROHN 45GSR
All parts shown in table are included when ordering
Part No: 45GSR90R100

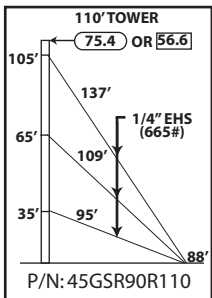

TOWER PARTS INCLUDED	45GSR20	45GSR10	45GSRSB	GA45GD	FDNS	
					BASE	ANCHOR
	5	1	1	3	FB1G	AB2
GUYS & CONNECTIONS INCLUDED	1/4EHS	BG2144	3/8THH	1/2TBE&J	TBSAFETY	
	1100'	18	18	9	3	
ANCHORS & GROUNDING INCLUDED	GAC3455TOP	AGK1GGX	BGK3GGX	CPC.5/.75		
	3	1	3	3		

110' ROHN 45GSR
All parts shown in table are included when ordering
Part No: 45GSR90R110

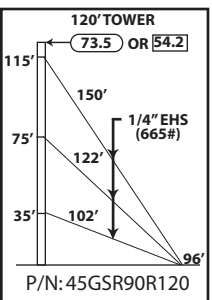

TOWER PARTS INCLUDED	45GSR20	45GSR10	45GSRSB	GA45GD	FDNS	
					BASE	ANCHOR
	6	1	1	3	FB1G	AB2
GUYS & CONNECTIONS INCLUDED	1/4EHS	BG2144	3/8THH	1/2TBE&J	TBSAFETY	
	1200'	18	18	9	3	
ANCHORS & GROUNDING INCLUDED	GAC3455TOP	AGK1GGX	BGK3GGX	CPC.5/.75		
	3	1	3	3		

120' ROHN 45GSR
All parts shown in table are included when ordering
Part No: 45GSR90R120

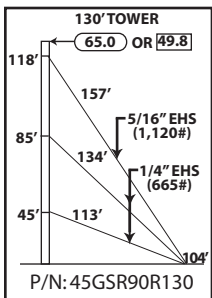

TOWER PARTS INCLUDED	45GSR20	45GSR10	45GSRSB	GA45GD	FDNS	
					BASE	ANCHOR
	6	1	1	3	FB1G	AB2
GUYS & CONNECTIONS INCLUDED	1/4EHS	142265	BG2144	BG2146		
	800'	500'	12	6		
	3/8THH	7/16THH	5/8TBE&J	1/2TBE&J		
	12	6	3	6		
ANCHORS & GROUNDING INCLUDED	GAC3455TOP	AGK1GGX	BGK3GGX	CPC.5/.75	TBSAFETY	
	3	1	3	3	3	

130' ROHN 45GSR
All parts shown in table are included when ordering
Part No: 45GSR90R130



STANDARD DESIGN - 45GSR
90MPH REV. G

45GSR
SOLID ROD

140' ROHN 45GSR

All parts shown in table are included when ordering
Part No: 45GSR90R140

150' ROHN 45GSR
All parts shown in table are included when ordering
Part No: 45GSR90R150

160' ROHN 45GSR
All parts shown in table are included when ordering
Part No: 45GSR90R160

170' ROHN 45GSR
All parts shown in table are included when ordering
Part No: 45GSR90R170

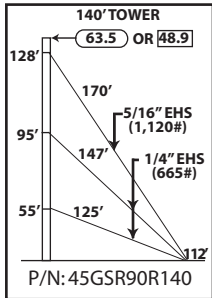

TOWER PARTS INCLUDED	45GSR20	45GSRSB	GA45GD	FDNS	
				BASE	ANCHOR
	7	1	3	FB1G	AB2
GUYS & CONNECTIONS INCLUDED	1/4EHS	142265	BG2144	BG2146	
	875'	550'	12	6	
	3/8THH	7/16THH	5/8TBE&J	1/2TBE&J	
	12	6	3	6	
ANCHORS & GROUNDING INCLUDED	GAC3455TOP	AGK1GGX	BGK3GGX	CPC.5/.75	TBSAFETY
	3	1	3	3	3

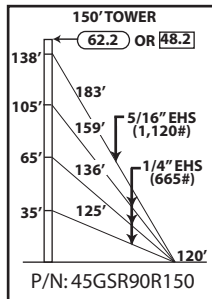

TOWER PARTS INCLUDED	45GSR20	45GSR10	45GSRSB	GA45GD	FDNS	
					BASE	ANCHOR
	7	1	1	4	FB1G	AB2
GUYS & CONNECTIONS INCLUDED	1/4EHS	142265	BG2144	BG2146		
	1350'	600'	18	6		
	3/8THH	7/16THH	5/8TBE&J	1/2TBE&J		
	18	6	3	9		
ANCHORS & GROUNDING INCLUDED	GAC3455TOP	AGK1GGX	BGK3GGX	CPC.5/.75	TBSAFETY	
	3	1	3	3	3	

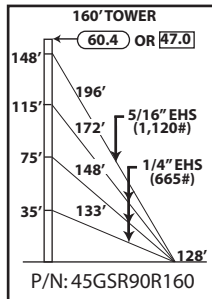

TOWER PARTS INCLUDED	45GSR20	45GSRSB	GA45GD	FDNS	
				BASE	ANCHOR
	8	1	4	FB1G	AB2
GUYS & CONNECTIONS INCLUDED	1/4EHS	142265	BG2144	BG2146	
	1450'	625'	18	6	
	3/8THH	7/16THH	5/8TBE&J	1/2TBE&J	
	18	6	3	9	
ANCHORS & GROUNDING INCLUDED	GAC3455TOP	AGK1GGX	BGK3GGX	CPC.5/.75	TBSAFETY
	3	1	3	3	3

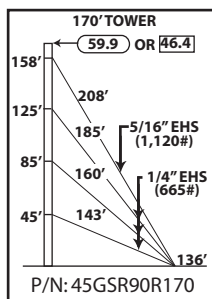

TOWER PARTS INCLUDED	45GSR20	45GSR10	45GSRSB	GA45GD	FDNS	
					BASE	ANCHOR
	8	1	1	4	FB1G	AB3
GUYS & CONNECTIONS INCLUDED	1/4EHS	142265	BG2144	BG2146		
	1575'	675'	18	6		
	3/8THH	7/16THH	5/8TBE&J	TBSAFETY		
	18	6	12	3		
ANCHORS & GROUNDING INCLUDED	GAC5655TOP	AGK1GGX	BGK3GGX	CPC1/1.25		
	3	1	3	3		





**STANDARD DESIGN - 45GSR
90MPH REV. G**

45GSR
SOLID ROD

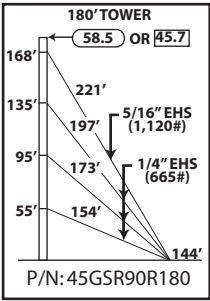

TOWER PARTS INCLUDED	45GSR20	45GSRSB	GA45GD	FDNS	
				BASE	ANCHOR
	9	1	4	FB1G	AB3
GUYS & CONNECTIONS INCLUDED	1/4EHS	142265	BG2144	BG2146	
	1675'	725'	18	6	
	3/8THH	7/16THH	5/8TBE&J	TBSAFETY	
	18	6	12	3	
ANCHORS & GROUNDING INCLUDED	GAC5655TOP	AGK1GGX	BGK3GGX	CPC1/1.25	
	3	1	3	3	

180' ROHN 45GSR
All parts shown in table are included when ordering
Part No: 45GSR90R180

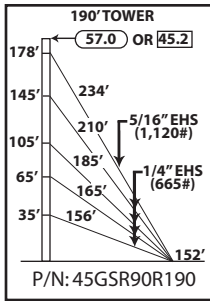

TOWER PARTS INCLUDED	45GSR20	45GSR10	45GSRSB	GA45GD	FDNS	
					BASE	ANCHOR
	9	1	1	5	FB1G	AB3
GUYS & CONNECTIONS INCLUDED	1/4EHS	142265	BG2144	BG2146		
	2300'	750'	24	6		
	3/8THH	7/16THH	5/8TBE&J	TBSAFETY		
	24	6	15	3		
ANCHORS & GROUNDING INCLUDED	GAC5655TOP	AGK1GGX	BGK3GGX	CPC1/1.25		
	3	1	3	3		

190' ROHN 45GSR
All parts shown in table are included when ordering
Part No: 45GSR90R190

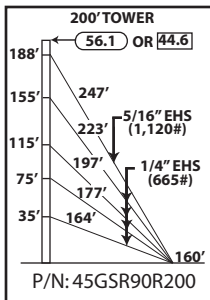

TOWER PARTS INCLUDED	45GSR20	45GSRSB	GA45GD	APL4A	FDNS	
					BASE	ANCHOR
	10	1	5	1	FB1G	AB3
GUYS & CONNECTIONS INCLUDED	1/4EHS	142265	BG2144	BG2146		
	2425'	800'	24	6		
	3/8THH	7/16THH	5/8TBE&J	TBSAFETY		
	24	6	15	3		
ANCHORS & GROUNDING INCLUDED	GAC5655TOP	AGK1GGX	BGK3GGX	CPC1/1.25		
	3	1	3	3		

200' ROHN 45GSR
All parts shown in table are included when ordering
Part No: 45GSR90R200

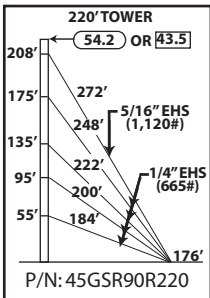

TOWER PARTS INCLUDED	45GSR20	45GSRSB	GA45GD	APL4A	FDNS	
					BASE	ANCHOR
	11	1	5	1	FB1G	AB3
GUYS & CONNECTIONS INCLUDED	1/4EHS	142265	BG2144	BG2146		
	2725'	875'	24	6		
	3/8THH	7/16THH	5/8TBE&J	TBSAFETY		
	24	6	15	3		
ANCHORS & GROUNDING INCLUDED	GAC5655TOP	AGK1GGX	BGK3GGX	CPC1/1.25		
	3	1	3	3		

220' ROHN 45GSR
All parts shown in table are included when ordering
Part No: 45GSR90R220



STANDARD DESIGN - 45GSR
90MPH REV. G

45GSR
SOLID ROD

240' ROHN 45GSR
All parts shown in table are included when ordering
Part No: 45GSR90R240

260' ROHN 45GSR
All parts shown in table are included when ordering
Part No: 45GSR90R260

280' ROHN 45GSR
All parts shown in table are included when ordering
Part No: 45GSR90R280

300' ROHN 45GSR
All parts shown in table are included when ordering
Part No: 45GSR90R300

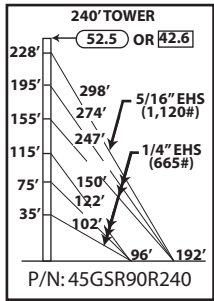

TOWER PARTS INCLUDED	45GSR20	45GSRSB	GA45GD	APL4A	BASE	INNER ANCHOR	OUTER ANCHOR
		12	1	6	1	FB1G	AB2
GUYS & CONNECTIONS INCLUDED	1/4EHS	142265	BG2144	BG2146			
	2850'	950'	30	6			
	3/8THH	7/16THH	5/8TBE&J	1/2TBE&J			
	30	6	3	15			
ANCHORS & GROUNDING INCLUDED	GAC3455TOP	AGK1GGX	BGK3GGX	CPC.5/.75	TBSAFETY		
	6	2	3	6	6		

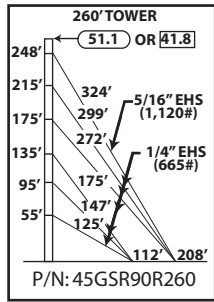

TOWER PARTS INCLUDED	45GSR20	45GSRSB	GA45GD	APL4A	BASE	INNER ANCHOR	OUTER ANCHOR
		13	1	6	1	FB1G	AB2
GUYS & CONNECTIONS INCLUDED	1/4EHS	142265	BG2144	BG2146			
	3250'	1050'	30	6			
	3/8THH	7/16THH	5/8TBE&J	1/2TBE&J			
	30	6	3	15			
ANCHORS & GROUNDING INCLUDED	GAC3455TOP	AGK1GGX	BGK3GGX	CPC.5/.75	TBSAFETY		
	6	2	3	6	6		

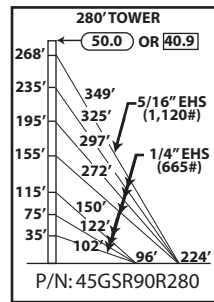

TOWER PARTS INCLUDED	45GSR20	45GSRSB	GA45GD	APL4A	BASE	INNER ANCHOR	OUTER ANCHOR
		14	1	7	1	FB1G	AB2
GUYS & CONNECTIONS INCLUDED	1/4EHS	142265	BG2144	BG2146	3/8THH		
	4050'	1125'	36	6	36		
	7/16THH	5/8TBE&J	1/2TBE&J	CPC.5/.75	CPC1/1.25		
	6	12	9	3	3		
ANCHORS & GROUNDING INCLUDED	GAC3455TOP	GAC5655TOP	AGK1GGX	BGK3GGX	TBSAFETY		
	3	3	2	3	6		

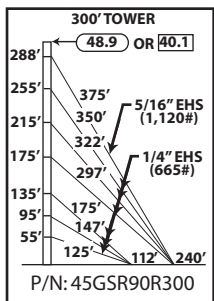

TOWER PARTS INCLUDED	45GSR20	45GSRSB	GA45GD	APL4A	BASE	INNER ANCHOR	OUTER ANCHOR
		15	1	7	1	FB1G	AB2
GUYS & CONNECTIONS INCLUDED	1/4EHS	142265	BG2144	BG2146	3/8THH		
	4525'	1200'	36	6	36		
	7/16THH	5/8TBE&J	1/2TBE&J	CPC.5/.75	CPC1/1.25		
	6	12	9	3	3		
ANCHORS & GROUNDING INCLUDED	GAC3455TOP	GAC5655TOP	AGK1GGX	BGK3GGX	TBSAFETY		
	3	3	2	3	6		



STANDARD DESIGN - 45GSR
90MPH REV. G

45GSR
SOLID ROD

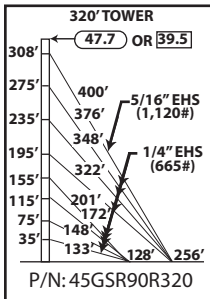

TOWER PARTS INCLUDED	45GSR20	45GSRSB	GA45GD	APL4A	BASE	INNER ANCHOR	OUTER ANCHOR
	16	1	8	1	FB1G	AB2	AB3
GUYS & CONNECTIONS INCLUDED	1/4EHS	142265	BG2144	BG2146	3/8THH		
	5450'	1275'	42	6	42		
	7/16THH	5/8TBE&J	1/2TBE&J	CPC.5/.75	CPC1/1.25		
	6	12	12	3	3		
ANCHORS & GROUNDING INCLUDED	GAC3455TOP	GAC5655TOP	AGK1GGX	BGK3GGX	TBSAFETY		
	3	3	2	3	6		

320' ROHN 45GSR
All parts shown in table are included when ordering
Part No: 45GSR90R320

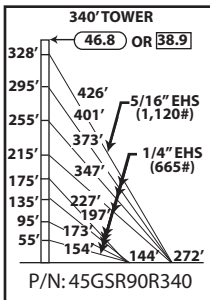

TOWER PARTS INCLUDED	45GSR20	45GSRSB	GA45GD	APL4A	BASE	INNER ANCHOR	OUTER ANCHOR
	17	1	8	1	FB1G	AB2	AB3
GUYS & CONNECTIONS INCLUDED	1/4EHS	142265	BG2144	BG2146	3/8THH		
	5975'	1375'	42	6	42		
	7/16THH	5/8TBE&J	1/2TBE&J	CPC.5/.75	CPC1/1.25		
	6	12	12	3	3		
ANCHORS & GROUNDING INCLUDED	GAC3455TOP	GAC5655TOP	AGK1GGX	BGK3GGX	TBSAFETY		
	3	3	2	3	6		

340' ROHN 45GSR
All parts shown in table are included when ordering
Part No: 45GSR90R340



STANDARD DESIGN - 45GSR 110MPH REV. G

45GSR
SOLID ROD

40' ROHN 45GSR
All parts shown in table are included when ordering
Part No: 45GSR110R040

50' ROHN 45GSR
All parts shown in table are included when ordering
Part No: 45GSR110R050

60' ROHN 45GSR
All parts shown in table are included when ordering
Part No: 45GSR110R060

70' ROHN 45GSR
All parts shown in table are included when ordering
Part No: 45GSR110R070

80' ROHN 45GSR
All parts shown in table are included when ordering
Part No: 45GSR110R080

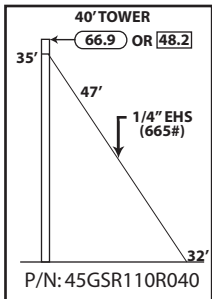

TOWER PARTS INCLUDED	45GSR20	45GSRSB	GA45GD	FDNS	
	2	1	1	BASE	ANCHOR
GUYS & CONNECTIONS INCLUDED	1/4EHS	BG2144	3/8THH	1/2TBE&J	TBSAFETY
	150'	6	6	3	3
ANCHORS & GROUNDING INCLUDED	GAC3455TOP	AGK1GGX	BGK3GGX	CPC.5/.75	
	3	1	3	3	

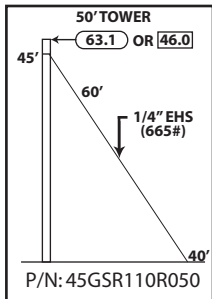

TOWER PARTS INCLUDED	45GSR20	45GSR10	45GSRSB	GA45GD	FDNS	
	2	1	1	1	BASE	ANCHOR
GUYS & CONNECTIONS INCLUDED	1/4EHS	BG2144	3/8THH	1/2TBE&J	TBSAFETY	
	200'	6	6	3	3	
ANCHORS & GROUNDING INCLUDED	GAC3455TOP	AGK1GGX	BGK3GGX	CPC.5/.75		
	3	1	3	3		

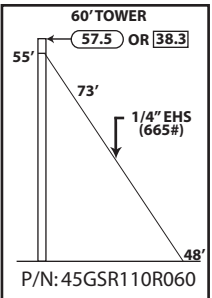

TOWER PARTS INCLUDED	45GSR20	45GSRSB	GA45GD	FDNS	
	3	1	1	BASE	ANCHOR
GUYS & CONNECTIONS INCLUDED	1/4EHS	BG2144	3/8THH	1/2TBE&J	TBSAFETY
	250'	6	6	3	3
ANCHORS & GROUNDING INCLUDED	GAC3455TOP	AGK1GGX	BGK3GGX	CPC.5/.75	
	3	1	3	3	

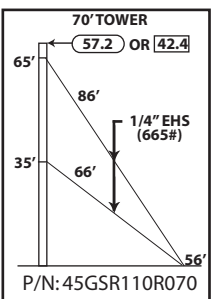

TOWER PARTS INCLUDED	45GSR20	45GSR10	45GSRSB	GA45GD	FDNS	
	3	1	1	2	BASE	ANCHOR
GUYS & CONNECTIONS INCLUDED	1/4EHS	BG2144	3/8THH	1/2TBE&J	TBSAFETY	
	500'	12	12	6	3	
ANCHORS & GROUNDING INCLUDED	GAC3455TOP	AGK1GGX	BGK3GGX	CPC.5/.75		
	3	1	3	3		

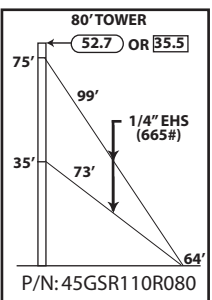

TOWER PARTS INCLUDED	45GSR20	45GSRSB	GA45GD	FDNS	
	4	1	2	BASE	ANCHOR
GUYS & CONNECTIONS INCLUDED	1/4EHS	BG2144	3/8THH	1/2TBE&J	TBSAFETY
	550'	12	12	6	3
ANCHORS & GROUNDING INCLUDED	GAC3455TOP	AGK1GGX	BGK3GGX	CPC.5/.75	
	3	1	3	3	



STANDARD DESIGN - 45GSR
110MPH REV. G

45GSR
SOLID ROD

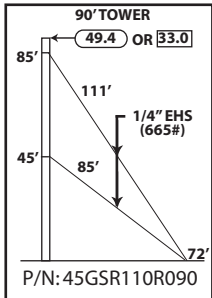

TOWER PARTS INCLUDED	45GSR20	45GSR10	45GSRSB	GA45GD	FDNS	
					BASE	ANCHOR
	4	1	1	2	FB2G	AB2
GUYS & CONNECTIONS INCLUDED	1/4EHS	BG2144	3/8THH	1/2TBE&J	TBSAFETY	
	625'	12	12	6	3	
ANCHORS & GROUNDING INCLUDED	GAC3455TOP	AGK1GGX	BGK3GGX	CPC.5/.75		
	3	1	3	3		

90' ROHN 45GSR
All parts shown in table are included when ordering
Part No: 45GSR110R090

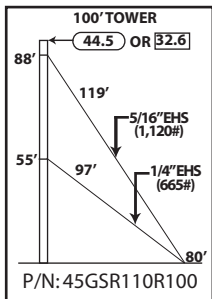

TOWER PARTS INCLUDED	45GSR20	45GSRSB	GA45GD	FDNS	
				BASE	ANCHOR
	5	1	2	FB2G	AB2
GUYS & CONNECTIONS INCLUDED	1/4EHS	142265	3/8THH	1/2TBE&J	5/8TBE&J
	325'	400'	6	3	3
	7/16THH	BG2144	BG2146	TBSAFETY	
	6	6	6	3	
ANCHORS & GROUNDING INCLUDED	GAC3455TOP	AGK1GGX	BGK3GGX	CPC.5/.75	
	3	1	3	3	

100' ROHN 45GSR
All parts shown in table are included when ordering
Part No: 45GSR110R100

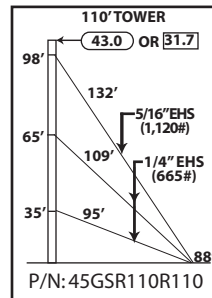

TOWER PARTS INCLUDED	45GSR20	45GSR10	45GSRSB	GA45GD	FDNS	
					BASE	ANCHOR
	5	1	1	3	FB2G	AB2
GUY WIRE & CONNECTION INCLUDED	1/4EHS	142265	3/8THH	1/2TBE&J	5/8TBE&J	
	650'	425'	12	6	3	
	7/16THH	BG2144	BG2146	TBSAFETY		
	6	12	6	3		
ANCHORS & GROUNDING INCLUDED	GAC3455TOP	AGK1GGX	BGK3GGX	CPC.5/.75		
	3	1	3	3		

110' ROHN 45GSR
All parts shown in table are included when ordering
Part No: 45GSR110R110

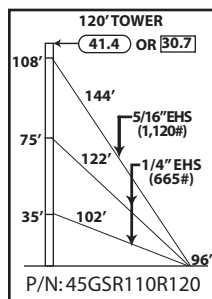

TOWER PARTS INCLUDED	45GSR20	45GSRSB	GA45GD	FDNS	
				BASE	ANCHOR
	6	1	3	FB2G	AB2
GUYS & CONNECTIONS INCLUDED	1/4EHS	142265	3/8THH	1/2TBE&J	5/8TBE&J
	725'	475'	12	6	3
	7/16THH	BG2144	BG2146	TBSAFETY	
	6	12	6	3	
ANCHORS & GROUNDING INCLUDED	GAC3455TOP	AGK1GGX	BGK3GGX	CPC.5/.75	
	3	1	3	3	

120' ROHN 45GSR
All parts shown in table are included when ordering
Part No: 45GSR110R120



STANDARD DESIGN - 45GSR
110MPH REV. G

45GSR
SOLID ROD

130' ROHN 45GSR
All parts shown in table are included when ordering
Part No: 45GSR110R130

140' ROHN 45GSR
All parts shown in table are included when ordering
Part No: 45GSR110R140

150' ROHN 45GSR
All parts shown in table are included when ordering
Part No: 45GSR110R150

160' ROHN 45GSR
All parts shown in table are included when ordering
Part No: 45GSR110R160

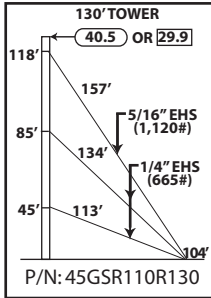

TOWER PARTS INCLUDED	45GSR20	45GSR10	45GSRSB	GA45GD	FDNS	
					BASE	ANCHOR
	6	1	1	3	FB2G	AB2
GUYS & CONNECTIONS INCLUDED	1/4EHS	142265	3/8THH	1/2TBE&J	5/8TBE&J	
	800'	500'	12	6	3	
	7/16THH	BG2144	BG2146	TBSAFETY		
	6	12	6	3		
ANCHORS & GROUNDING INCLUDED	GAC3455TOP	AGK1GGX	BGK3GGX	CPC.5/.75		
	3	1	3	3		

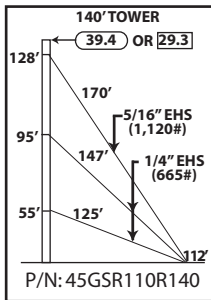

TOWER PARTS INCLUDED	45GSR20	45GSRSB	GA45GD	FDNS		
				BASE	ANCHOR	
	7	1	3	FB2G	AB2	
GUYS & CONNECTIONS INCLUDED	1/4EHS	142265	3/8THH	1/2TBE&J	5/8TBE&J	
	875'	550'	12	6	3	
	7/16THH	BG2144	BG2146	TBSAFETY		
	6	12	6	3		
ANCHORS & GROUNDING INCLUDED	GAC3455TOP	AGK1GGX	BGK3GGX	CPC.5/.75		
	3	1	3	3		

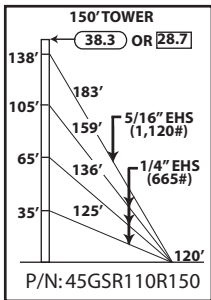

TOWER PARTS INCLUDED	45GSR20	45GSR10	45GSRSB	GA45GD	FDNS	
					BASE	ANCHOR
	7	1	1	4	FB2G	AB3
GUYS & CONNECTIONS INCLUDED	1/4EHS	142265	3/8THH	5/8TBE&J		
	1350'	600'	18	12		
	7/16THH	BG2144	BG2146	TBSAFETY		
	6	18	6	3		
ANCHORS & GROUNDING INCLUDED	GAC5655TOP	AGK1GGX	BGK3GGX	CPC1/1.25		
	3	1	3	3		

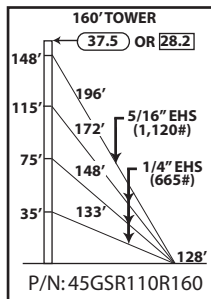

TOWER PARTS INCLUDED	45GSR20	45GSRSB	GA45GD	FDNS		
				BASE	ANCHOR	
	8	1	4	FB2G	AB3	
GUYS & CONNECTIONS INCLUDED	1/4EHS	142265	3/8THH	5/8TBE&J		
	1450'	625'	18	12		
	7/16THH	BG2144	BG2146	TBSAFETY		
	6	18	6	3		
ANCHORS & GROUNDING INCLUDED	GAC5655TOP	AGK1GGX	BGK3GGX	CPC1/1.25		
	3	1	3	3		



**STANDARD DESIGN - 45GSR
110MPH REV. G**

45GSR
SOLID ROD

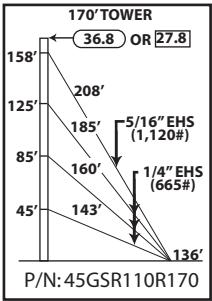

TOWER PARTS INCLUDED	45GSR20	45GSR10	45GSRSB	GA45GD	FDNS	
					BASE	ANCHOR
	8	1	1	4	FB2G	AB3
GUYS & CONNECTIONS INCLUDED	1/4EHS	142265	3/8THH	5/8TB&J		
	1575'	675'	18	12		
	7/16THH	BG2144	BG2146	TBSAFETY		
	6	18	6	3		
ANCHORS & GROUNDING INCLUDED	GAC5655TOP	AGK1GGX	BGK3GGX	CPC1/1.25		
	3	1	3	3		

170' ROHN 45GSR
All parts shown in table are included when ordering
Part No: 45GSR110R170

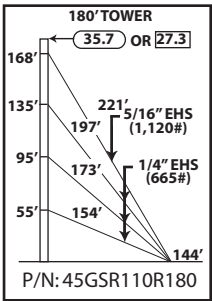

TOWER PARTS INCLUDED	45GSR20	45GSRSB	GA45GD	FDNS		
				BASE	ANCHOR	
	9	1	4	FB2G	AB3	
GUYS & CONNECTIONS INCLUDED	1/4EHS	142265	3/8THH	5/8TB&J		
	1675'	725'	18	12		
	7/16THH	BG2144	BG2146	TBSAFETY		
	6	18	6	3		
ANCHORS & GROUNDING INCLUDED	GAC5655TOP	AGK1GGX	BGK3GGX	CPC1/1.25		
	3	1	3	3		

180' ROHN 45GSR
All parts shown in table are included when ordering
Part No: 45GSR110R180

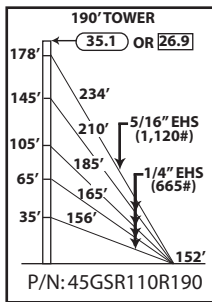

TOWER PARTS INCLUDED	45GSR20	45GSR10	45GSRSB	GA45GD	FDNS	
					BASE	ANCHOR
	9	1	1	5	FB2G	AB3
GUYS & CONNECTIONS INCLUDED	1/4EHS	142265	3/8THH	5/8TB&J		
	2300'	750'	24	15		
	7/16THH	BG2144	BG2146	TBSAFETY		
	6	24	6	3		
ANCHORS & GROUNDING INCLUDED	GAC5655TOP	AGK1GGX	BGK3GGX	CPC1/1.25		
	3	1	3	3		

190' ROHN 45GSR
All parts shown in table are included when ordering
Part No: 45GSR110R190

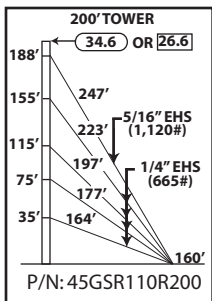

TOWER PARTS INCLUDED	45GSR20	45GSRSB	GA45GD	APL4A	FDNS	
					BASE	ANCHOR
	10	1	5	1	FB2G	AB4
GUYS & CONNECTIONS INCLUDED	1/4EHS	142265	3/8THH	5/8TB&J		
	2425'	800'	24	15		
	7/16THH	BG2144	BG2146	TBSAFETY		
	6	24	6	3		
ANCHORS & GROUNDING INCLUDED	GAC5655TOP	AGK1GGX	BGK3GGX	CPC1/1.25		
	3	1	3	3		

200' ROHN 45GSR
All parts shown in table are included when ordering
Part No: 45GSR110R200



STANDARD DESIGN - 45GSR 110MPH REV. G

45GSR
SOLID ROD

220' ROHN 45GSR
All parts shown in table
are included when ordering
Part No: 45GSR110R220

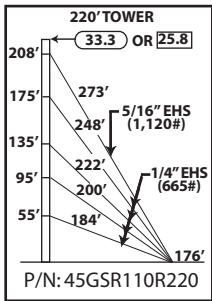

TOWER PARTS INCLUDED	45GSR20	45GSRSB	GA45GD	APL4A	FDNS	
	11	1	5	1	BASE	ANCHOR
GUYS & CONNECTIONS INCLUDED	1/4EHS	142265	3/8THH	5/8TBE&J		
	2725'	875'	24	15		
	7/16THH	BG2144	BG2146	TBSAFETY		
ANCHORS & GROUNDING INCLUDED	6	24	6	3		
	GAC5655TOP	AGK1GGX	BGK3GGX	CPC1/1.25		
	3	1	3	3		

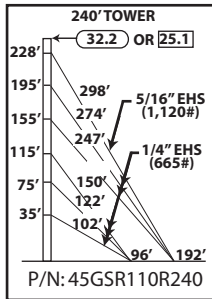

TOWER PARTS INCLUDED	45GSR20	45GSRSB	GA45GD	APL4A	BASE	INNER ANCHOR	OUTER ANCHOR
		12	1	6	1	FB2G	AB2
GUYS & CONNECTIONS INCLUDED	1/4EHS	142265	BG2144	BG2146	3/8THH		
	2850'	950'	30	6	30		
	7/16THH	5/8TBE&J	1/2TBE&J	CPC.5/.75	CPC1/1.25		
ANCHORS & GROUNDING INCLUDED	6	9	9	3	3		
	GAC3455TOP	GAC5655TOP	AGK1GGX	BGK3GGX	TBSAFETY		
	3	3	2	3	6		

240' ROHN 45GSR
All parts shown in
table are included
when ordering
Part No: 45GSR110R240

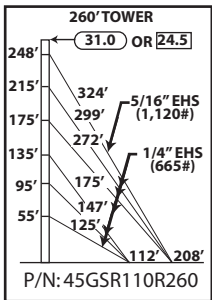

TOWER PARTS INCLUDED	45GSR20	45GSRSB	GA45GD	APL4A	BASE	INNER ANCHOR	OUTER ANCHOR
		13	1	6	1	FB2G	AB2
GUYS & CONNECTIONS INCLUDED	1/4EHS	142265	BG2144	BG2146	3/8THH		
	3250'	1050'	30	6	30		
	7/16THH	5/8TBE&J	1/2TBE&J	CPC.5/.75	CPC1/1.25		
ANCHORS & GROUNDING INCLUDED	6	9	9	3	3		
	GAC3455TOP	GAC5655TOP	AGK1GGX	BGK3GGX	TBSAFETY		
	3	3	2	3	6		

260' ROHN 45GSR
All parts shown in table
are included when ordering
Part No: 45GSR110R260

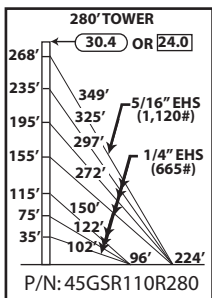

TOWER PARTS INCLUDED	45GSR20	45GSRSB	GA45GD	APL4A	BASE	INNER ANCHOR	OUTER ANCHOR
		14	1	7	1	FB2G	AB2
GUYS & CONNECTIONS INCLUDED	1/4EHS	142265	BG2144	BG2146	3/8THH		
	4050'	1125'	36	6	36		
	7/16THH	5/8TBE&J	1/2TBE&J	CPC.5/.75	CPC1/1.25		
ANCHORS & GROUNDING INCLUDED	6	12	9	3	3		
	GAC3455TOP	GAC5655TOP	AGK1GGX	BGK3GGX	TBSAFETY		
	3	3	2	3	6		

280' ROHN 45GSR
All parts shown in table
are included when ordering
Part No: 45GSR110R280



STANDARD DESIGN - 45GSR
110MPH REV. G

45GSR
SOLID ROD

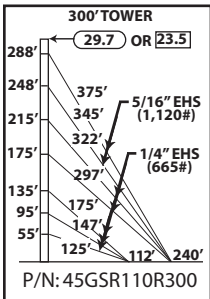

TOWER PARTS INCLUDED	45GSR20	45GSRSB	GA45GD	APL4A	BASE	INNER ANCHOR	OUTER ANCHOR
		15	1	7	1	FB2G	AB2
GUYS & CONNECTIONS INCLUDED	1/4EHS	142265	BG2144	BG2146	3/8THH		
	3400'	2300'	30	12	30		
	7/16THH	5/8TBE&J	1/2TBE&J	CPC.5/1.75	CPC1/1.25		
	12	12	9	3	3		
ANCHORS & GROUNDING INCLUDED	GAC3455TOP	GAC5655TOP	AGK1GGX	BGK3GGX	TBSAFETY		
	3	3	2	3	6		

300' ROHN 45GSR
All parts shown in table are included when ordering
Part No: 45GSR110R300

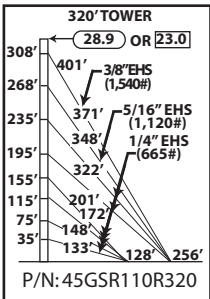

TOWER PARTS INCLUDED	45GSR20	45GSRSB	GA45GD	APL4A	BASE	INNER ANCHOR	OUTER ANCHOR
		15	1	7	1	FB2G	AB3
GUYS & CONNECTIONS INCLUDED	1/4EHS	142265	142261	BG2144	BG2146	BG2147	5/8S
	4225'	1200'	1300'	36	6	6	3
	1/2THH	3/8THH	7/16THH	5/8TBE&J	5/8S	45GSR20L82*	
	6	36	6	24	3	1	
ANCHORS & GROUNDING INCLUDED	GAC5655TOP	AGK1GGX	BGK3GGX	CPC1/1.25	TBSAFETY		
	6	2	3	6	6		

320' ROHN 45GSR
All parts shown in table are included when ordering
Part No: 45GSR110R320

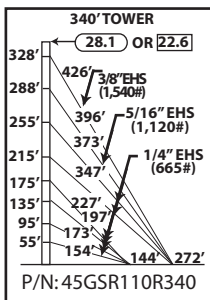

TOWER PARTS INCLUDED	45GSR20	45GSRSB	GA45GD	APL4A	BASE	INNER ANCHOR	OUTER ANCHOR
		16	1	7	1	FB2G	AB3
GUYS & CONNECTIONS INCLUDED	1/4EHS	142265	142261	BG2144	BG2146	BG2147	5/8S
	4700'	1275'	1375'	36	6	6	3
	1/2THH	3/8THH	7/16THH	5/8TBE&J	5/8S	45GSR20L82*	
	6	36	6	24	3	1	
ANCHORS & GROUNDING INCLUDED	GAC5655TOP	AGK1GGX	BGK3GGX	CPC1/1.25	TBSAFETY		
	6	2	3	6	6		

340' ROHN 45GSR
All parts shown in table are included when ordering
Part No: 45GSR110R340

* Guy lug sections required for 3/8" guys.



STANDARD DESIGN - 45GSR
130MPH REV. G

45GSR
SOLID ROD

40' ROHN 45GSR
All parts shown in table are included when ordering
Part No: 45GSR130R040

50' ROHN 45GSR
All parts shown in table are included when ordering
Part No: 45GSR90R050

60' ROHN 45GSR
All parts shown in table are included when ordering
Part No: 45GSR90R060

70' ROHN 45GSR
All parts shown in table are included when ordering
Part No: 45GSR130R070

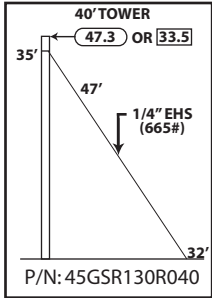

TOWER PARTS INCLUDED	45GSR20	45GSRSB	GA45GD	FDNS	
	2	1	1	BASE	ANCHOR
GUYS & CONNECTIONS INCLUDED	1/4EHS	BG2144	3/8THH	1/2TBE&J	TBSAFETY
	150'	6	6	3	3
ANCHORS & GROUNDING INCLUDED	GAC3455TOP	AGK1GGX	BGK3GGX	CPC.5/.75	
	3	1	3	3	

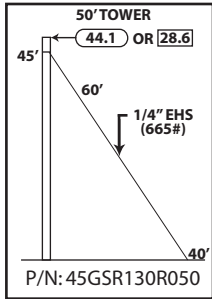

TOWER PARTS INCLUDED	45GSR20	45GSR10	45GSRSB	GA45GD	FDNS	
	2	1	1	1	BASE	ANCHOR
GUYS & CONNECTIONS INCLUDED	1/4EHS	BG2144	3/8THH	1/2TBE&J	TBSAFETY	
	200'	6	6	3	3	
ANCHORS & GROUNDING INCLUDED	GAC3455TOP	AGK1GGX	BGK3GGX	CPC.5/.75		
	3	1	3	3		

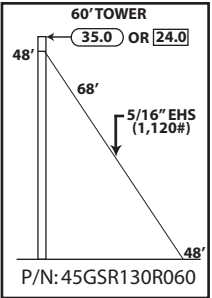

TOWER PARTS INCLUDED	45GSR20	45GSRSB	GA45GD	FDNS	
	3	1	1	BASE	ANCHOR
GUYS & CONNECTIONS INCLUDED	142265	BG2146	7/16THH	5/8TBE&J	TBSAFETY
	225'	6	6	3	3
ANCHORS & GROUNDING INCLUDED	GAC3455TOP	AGK1GGX	BGK3GGX	CPC.5/.75	
	3	1	3	3	

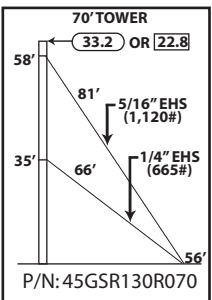

TOWER PARTS INCLUDED	45GSR20	45GSR10	45GSRSB	GA45GD	FDNS	
	3	1	1	2	BASE	ANCHOR
GUYS & CONNECTIONS INCLUDED	1/4EHS	142265	BG2144	BG2146	3/8THH	
	225'	275'	6	6	6	
	7/16THH	1/2TBE&J	5/8TBE&J	TBSAFETY		
	6	3	3	3		
ANCHORS & GROUNDING INCLUDED	GAC3455TOP	AGK1GGX	BGK3GGX	CPC.5/.75		
	3	1	3	3		



STANDARD DESIGN - 45GSR
130MPH REV. G

45GSR
SOLID ROD

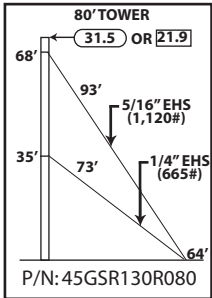

TOWER PARTS INCLUDED	45GSR20	45GSRSB	GA45GD	FDNS	
				BASE	ANCHOR
	4	1	2	FB2G	AB2
GUYS & CONNECTIONS INCLUDED	1/4EHS	142265	BG2144	BG2146	3/8THH
	250'	300'	6	6	6
	7/16THH	1/2TBE&J	5/8TBE&J	TBSAFETY	
	6	3	3	3	
ANCHORS & GROUNDING INCLUDED	GAC3455TOP	AGK1GGX	BGK3GGX	CPC.5/.75	
	3	1	3	3	

80' ROHN 45GSR
All parts shown in table are included when ordering
Part No: 45GSR130R080

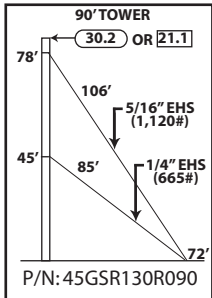

TOWER PARTS INCLUDED	45GSR20	45GSR10	45GSRSB	GA45GD	FDNS	
					BASE	ANCHOR
	4	1	1	2	FB2G	AB2
GUYS & CONNECTIONS INCLUDED	1/4EHS	142265	BG2144	BG2146	3/8THH	
	275'	350'	6	6	6	
	7/16THH	1/2TBE&J	5/8TBE&J	TBSAFETY		
	6	3	3	3		
ANCHORS & GROUNDING INCLUDED	GAC3455TOP	AGK1GGX	BGK3GGX	CPC.5/.75		
	3	1	3	3		

90' ROHN 45GSR
All parts shown in table are included when ordering
Part No: 45GSR130R090

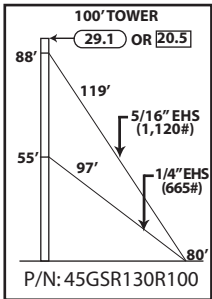

TOWER PARTS INCLUDED	45GSR20	45GSRSB	GA45GD	FDNS	
				BASE	ANCHOR
	5	1	2	FB2G	AB2
GUYS & CONNECTIONS INCLUDED	1/4EHS	142265	BG2144	BG2146	3/8THH
	325'	400'	6	6	6
	7/16THH	1/2TBE&J	5/8TBE&J	TBSAFETY	
	6	3	3	3	
ANCHORS & GROUNDING INCLUDED	GAC3455TOP	AGK1GGX	BGK3GGX	CPC.5/.75	
	3	1	3	3	

100' ROHN 45GSR
All parts shown in table are included when ordering
Part No: 45GSR130R100

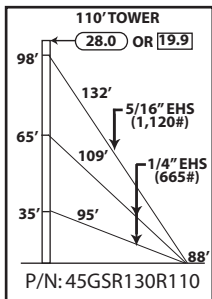

TOWER PARTS INCLUDED	45GSR20	45GSR10	45GSRSB	GA45GD	FDNS	
					BASE	ANCHOR
	5	1	1	3	FB2G	AB3
GUYS & CONNECTIONS INCLUDED	1/4EHS	142265	BG2144	BG2146		
	650'	425'	12	6		
	3/8THH	7/16THH	5/8TBE&J	TBSAFETY		
	12	6	9	3		
ANCHORS & GROUNDING INCLUDED	GAC5655TOP	AGK1GGX	BGK3GGX	CPC1/1.25		
	3	1	3	3		

110' ROHN 45GSR
All parts shown in table are included when ordering
Part No: 45GSR130R110



STANDARD DESIGN - 45GSR
130MPH REV. G

45GSR
SOLID ROD

120' ROHN 45GSR
All parts shown in table are included when ordering
Part No: 45GSR130R120

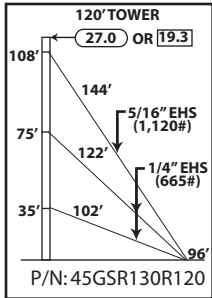

TOWER PARTS INCLUDED	45GSR20	45GSRSB	GA45GD	FDNS	
				BASE	ANCHOR
	6	1	3	FB2G	AB3
GUYS & CONNECTIONS INCLUDED	1/4EHS	142265	BG2144	BG2146	
	725'	475'	12	6	
	3/8THH	7/16THH	5/8TBE&J	TBSAFETY	
	12	6	9	3	
ANCHORS & GROUNDING INCLUDED	GAC5655TOP	AGK1GGX	BGK3GGX	CPC1/1.25	
	3	1	3	3	

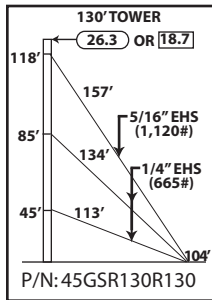

TOWER PARTS INCLUDED	45GSR20	45GSR10	45GSRSB	GA45GD	FDNS	
					BASE	ANCHOR
	6	1	1	3	FB2G	AB3
GUYS & CONNECTIONS INCLUDED	1/4EHS	142265	BG2144	BG2146		
	800'	500'	12	6		
	3/8THH	7/16THH	5/8TBE&J	TBSAFETY		
	12	6	9	3		
ANCHORS & GROUNDING INCLUDED	GAC5655TOP	AGK1GGX	BGK3GGX	CPC1/1.25		
	3	1	3	3		

130' ROHN 45GSR
All parts shown in table are included when ordering
Part No: 45GSR130R130

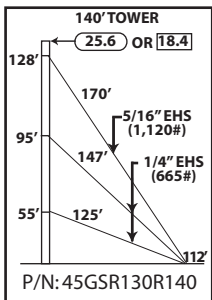

TOWER PARTS INCLUDED	45GSR20	45GSRSB	GA45GD	FDNS	
				BASE	ANCHOR
	7	1	3	FB2G	AB3
GUYS & CONNECTIONS INCLUDED	1/4EHS	142265	BG2144	BG2146	
	875'	550'	12	6	
	3/8THH	7/16THH	5/8TBE&J	TBSAFETY	
	12	6	9	3	
ANCHORS & GROUNDING INCLUDED	GAC5655TOP	AGK1GGX	BGK3GGX	CPC1/1.25	
	3	1	3	3	

140' ROHN 45GSR
All parts shown in table are included when ordering
Part No: 45GSR130R140

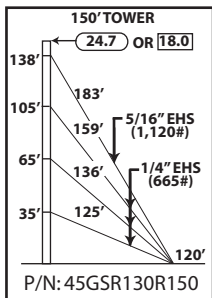

TOWER PARTS INCLUDED	45GSR20	45GSR10	45GSRSB	GA45GD	FDNS	
					BASE	ANCHOR
	7	1	1	4	FB2G	AB4
GUYS & CONNECTIONS INCLUDED	1/4EHS	142265	BG2144	BG2146		
	1350'	600'	18	6		
	3/8THH	7/16THH	3/4TBE&J	TBSAFETY		
	18	6	12	3		
ANCHORS & GROUNDING INCLUDED	GAC5755TOP	AGK1GGX	BGK3GGX	CPC1.5/2		
	3	1	3	3		

150' ROHN 45GSR
All parts shown in table are included when ordering
Part No: 45GSR130R150



STANDARD DESIGN - 45GSR
130MPH REV. G

45GSR
SOLID ROD

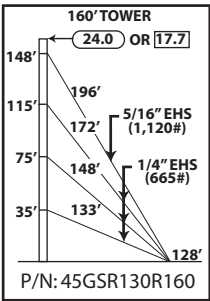

TOWER PARTS INCLUDED	45GSR20	45GSRSB	GA45GD	FDNS	
				BASE	ANCHOR
	8	1	4	FB2G	AB4
GUYS & CONNECTIONS INCLUDED	1/4EHS	142265	BG2144	BG2146	
	1450'	625'	18	6	
	3/8THH	7/16THH	3/4TBE&J	TBSAFETY	
	18	6	12	3	
ANCHORS & GROUNDING INCLUDED	GAC5755TOP	AGK1GGX	BGK3GGX	CPC1.5/2	
	3	1	3	3	

160' ROHN 45GSR
All parts shown in table are included when ordering
Part No: 45GSR130R160

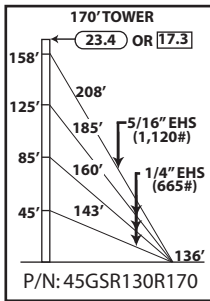

TOWER PARTS INCLUDED	45GSR20	45GSR10	45GSRSB	GA45GD	FDNS	
					BASE	ANCHOR
	8	1	1	4	FB2G	AB4
GUYS & CONNECTIONS INCLUDED	1/4EHS	142265	BG2144	BG2146		
	1575'	675'	18	6		
	3/8THH	7/16THH	3/4TBE&J	TBSAFETY		
	18	6	12	3		
ANCHORS & GROUNDING INCLUDED	GAC5755TOP	AGK1GGX	BGK3GGX	CPC1.5/2		
	3	1	3	3		

170' ROHN 45GSR
All parts shown in table are included when ordering
Part No: 45GSR130R170

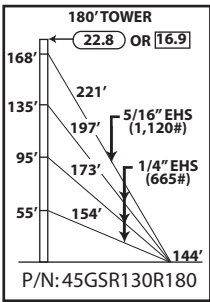

TOWER PARTS INCLUDED	45GSR20	45GSRSB	GA45GD	FDNS	
				BASE	ANCHOR
	9	1	4	FB2G	AB4
GUYS & CONNECTIONS INCLUDED	1/4EHS	142265	BG2144	BG2146	
	1675'	725'	18	6	
	3/8THH	7/16THH	3/4TBE&J	TBSAFETY	
	18	6	12	3	
ANCHORS & GROUNDING INCLUDED	GAC5755TOP	AGK1GGX	BGK3GGX	CPC1.5/2	
	3	1	3	3	

180' ROHN 45GSR
All parts shown in table are included when ordering
Part No: 45GSR130R180

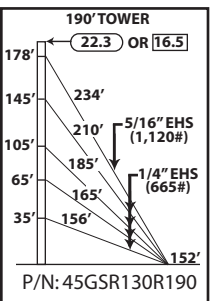

TOWER PARTS INCLUDED	45GSR20	45GSR10	45GSRSB	GA45GD	FDNS	
					BASE	ANCHOR
	9	1	1	5	FB2G	AB4
GUYS & CONNECTIONS INCLUDED	1/4EHS	142265	BG2144	BG2146		
	2300'	750'	24	6		
	3/8THH	7/16THH	3/4TBE&J	TBSAFETY		
	24	6	15	3		
ANCHORS & GROUNDING INCLUDED	GAC5755TOP	AGK1GGX	BGK3GGX	CPC1.5/2		
	3	1	3	3		

190' ROHN 45GSR
All parts shown in table are included when ordering
Part No: 45GSR130R190



STANDARD DESIGN - 45GSR 130MPH REV. G

45GSR
SOLID ROD

200' ROHN 45GSR
All parts shown in table
are included when ordering
Part No: 45GSR130R200

220' ROHN 45GSR
All parts shown in table
are included when ordering
Part No: 45GSR130R220

240' ROHN 45GSR
All parts shown in table
are included when ordering
Part No: 45GSR130R240

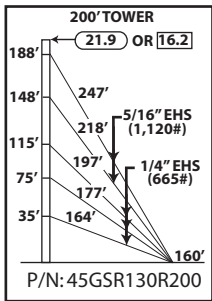

TOWER PARTS INCLUDED	45GSR20	45GSRSB	GA45GD	APL4A	FDNS	
	10	1	5	1	BASE	ANCHOR
GUYS & CONNECTIONS INCLUDED	1/4EHS	142265	BG2144	BG2146		
	1725'	1500'	18	12		
	3/8THH	7/16THH	3/4TBE&J	TBSAFETY		
	18	12	15	3		
ANCHORS & GROUNDING INCLUDED	GAC5755TOP	AGK1GGX	BGK3GGX	CPC1.5/2		
	3	1	3	3		

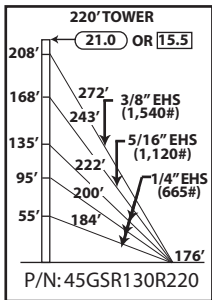

TOWER PARTS INCLUDED	45GSR20	45GSRSB	GA45GD	APL4A	FDNS	
	10	1	4	1	BASE	ANCHOR
GUYS & CONNECTIONS INCLUDED	1/4EHS	142265	142261	BG2144	45GSR20L82*	
	1950'	775'	875'	18	1	
	BG2146	BG2147	7/16THH	1/2THH		
	6	6	6	6		
	3/8THH	5/8S	3/4TBE&J	TBSAFETY		
	18	3	15	3		
ANCHORS & GROUNDING INCLUDED	GAC5755TOP	AGK1GGX	BGK3GGX	CPC1.5/2		
	3	1	3	3		

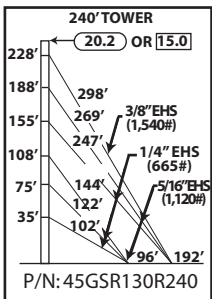

TOWER PARTS INCLUDED	45GSR20	45GSRSB	GA45GD	APL4A	BASE	INNER ANCHOR	OUTER ANCHOR
	11	1	5	1	FB2G	AB3	AB4
GUYS & CONNECTIONS INCLUDED	1/4EHS	142265	142261	BG2144	45GSR20L82*		
	1500'	1325'	950'	18	1		
	BG2146	BG2147	7/16THH	1/2THH			
	12	6	12	6			
	3/8THH	5/8S	5/8TBE&J	TBSAFETY			
	18	3	18	6			
ANCHORS & GROUNDING INCLUDED	GAC5655TOP	AGK1GGX	BGK3GGX	CPC1/1.25			
	6	2	3	6			

* Guy lug section required for 3/8" guys.



STANDARD DESIGN - 45GSR
130MPH REV. G

45GSR
SOLID ROD

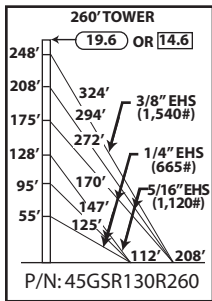

TOWER PARTS INCLUDED	45GSR20	45GSRSB	GA45GD	APL4A	BASE	INNER ANCHOR	OUTER ANCHOR
	12	1	5	1	FB2G	AB3	AB4
GUYS & CONNECTIONS INCLUDED	1/4EHS	142265	142261	BG2144	45GSR20.82'		
	1750'	1500'	1050'	18	1		
	BG2146	BG2147	7/16THH	1/2THH			
	12	6	12	6			
	3/8THH	5/8S	5/8TBE&J	TBSAFETY			
	18	3	18	6			
ANCHORS & GROUNDING INCLUDED	GAC5655TOP	AGK1GGX	BGK3GGX	CPC1/1.25			
	6	2	3	6			

260' ROHN 45GSR
All parts shown in table are included when ordering
Part No: 45GSR130R260

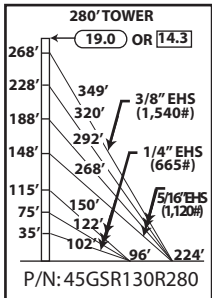

TOWER PARTS INCLUDED	45GSR20	45GSRSB	GA45GD	APL4A	BASE	INNER ANCHOR	OUTER ANCHOR
	13	1	6	1	FB2G	AB3	AB5
GUYS & CONNECTIONS INCLUDED	1/4EHS	142265	142261	BG2144	45GSR20.82'		
	1200'	2800'	1125'	18	1		
	BG2146	BG2147	7/16THH	1/2THH			
	18	6	18	6			
	3/8THH	5/8S	3/4TBE&J	TBSAFETY			
	18	3	21	6			
ANCHORS & GROUNDING INCLUDED	GAC5755TOP	AGK1GGX	BGK3GGX	CPC1.5/2			
	6	2	3	6			

280' ROHN 45GSR
All parts shown in table are included when ordering
Part No: 45GSR130R280

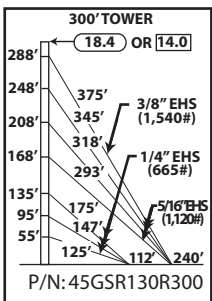

TOWER PARTS INCLUDED	45GSR20	45GSRSB	GA45GD	APL4A	BASE	INNER ANCHOR	OUTER ANCHOR
	14	1	6	1	FB3G	AB3	AB5
GUYS & CONNECTIONS INCLUDED	1/4EHS	142265	142261	BG2144	45GSR20.82'		
	1425'	3050'	1200'	18	1		
	BG2146	BG2147	7/16THH	1/2THH			
	18	6	18	6			
	3/8THH	5/8S	3/4TBE&J	TBSAFETY			
	18	3	21	6			
ANCHORS & GROUNDING INCLUDED	GAC5755TOP	AGK1GGX	BGK3GGX	CPC1.5/2			
	6	2	3	6			

300' ROHN 45GSR
All parts shown in table are included when ordering
Part No: 45GSR130R300

* Guy lug section required for 3/8" guys.



STANDARD DESIGN - 45GSR
130MPH REV. G

45GSR
SOLID ROD

320' ROHN 45GSR
All parts shown in table are included when ordering
Part No: 45GSR130R320

340' ROHN 45GSR
All parts shown in table are included when ordering
Part No: 45GSR130R340

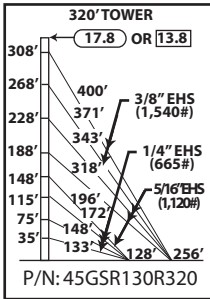

TOWER PARTS INCLUDED	45GSR20	45GSRSB	GA45GD	APL4A	BASE	INNER ANCHOR	OUTER ANCHOR
	14	1	6	1	FB3G	AB3	AB5
GUYS & CONNECTIONS INCLUDED	1/4EHS	142265	142261	BG2144	45GSR20L82*		
	1450'	2750'	2475'	18	2		
	BG2146	BG2147	7/16THH	1/2THH			
	18	12	18	12			
	3/8THH	5/8S	3/4TBE&J	TBSAFETY			
	18	6	24	6			
ANCHORS & GROUNDING INCLUDED	GAC5755TOP	AGK1GGX	BGK3GGX	CPC1.5/2			
	6	2	3	6			

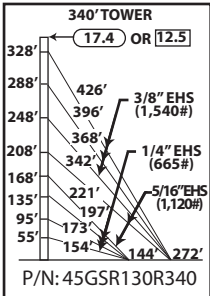

TOWER PARTS INCLUDED	45GSR20	45GSRSB	GA45GD	APL4A	BASE	INNER ANCHOR	OUTER ANCHOR
	14	1	5	1	FB3G	AB4	AB5
GUYS & CONNECTIONS INCLUDED	1/4EHS	142265	142261	BG2144	45GSR20L82*		
	1675'	1800'	3800'	18	3		
	BG2146	BG2147	7/16THH	1/2THH			
	12	18	12	18			
	3/8THH	5/8S	3/4TBE&J	TBSAFETY			
	18	9	24	6			
ANCHORS & GROUNDING INCLUDED	GAC5755TOP	AGK1GGX	BGK3GGX	CPC1.5/2			
	6	2	3	6			

* Guy lug section required for 3/8" guys.

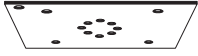
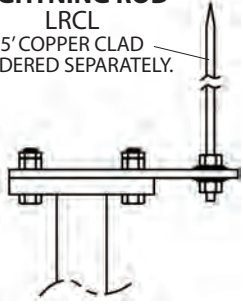
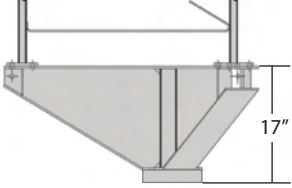
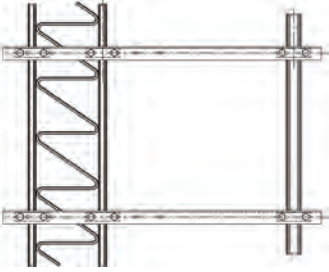
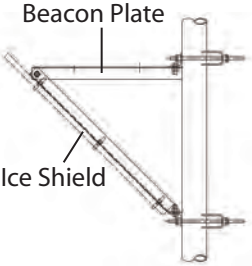
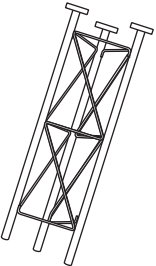

PARTS & ACCESSORIES

 <p>LEG MOUNTED BEACON PLATE KIT APL4A FOR MOUNTING BEACON OR LIGHTNING ROD. BOLTS TO TOP OF STANDARD SECTION. INCLUDES BEACON PLATE, (2) CAP PLATES, NUTS AND BOLTS.</p>	<p>LIGHTNING ROD LRCL 5' COPPER CLAD ORDERED SEPARATELY.</p>  <p>LIGHTNING ROD PLATE KIT VW132 INCLUDES: LIGHTNING ROD PLATE, NUTS AND BOLTS.</p>	 <p>TAPERED BASE 45GSRTBPP* FOR USE WITH PIER PIN (3/4X12PP) AND BEARING PLATE (BP6) SOLD SEPARATELY.</p>	 <p>3' SIDE ARM WITH (2) TIE BACKS KY1653A MOUNTING TUBE PROVIDED IS 3' LONG, 2 - 3/8" O.D.</p>
 <p>MID BEACON PLATE / ICE SHIELD APL1258UM</p>	 <p>4.3' SHORT BASE 45GSRB FOR EMBEDMENT IN CONCRETE.</p>		

Refer to pages 63-65 for the following accessories that also fit the 45GSR tower:

- Pier Pin (3/4x12PP)
- Side Arm Bracket (SA253UA)
- Dish Mount (VY4311A2 & VY4311A)
- Face Mount (DM45G2 & DM454)
- Universal House Bracket (HBUTVRO)
- Torque Bar (TB45D)
- Guy Bracket (GA45GD)
- Anti-Climb Panels (VW913A)
- Work Platform (WP45G)
- Safety Ring (SR245)
- Climbing Harness (TTFBH-4D & TTFBH-C/P)
- Safety Cable Slider (TT-WG-500-W/SMC)
- Safety Cable System (See page 65 for P/N)

* TOWERS MOUNTED ON THESE BASES MUST BE BRACKETED OR GUYED AT ALL TIMES. TEMPORARY STEEL GUYING MAY ALSO BE NECESSARY DURING INSTALLATION AND DISMANTLING.



ANCHOR INFORMATION

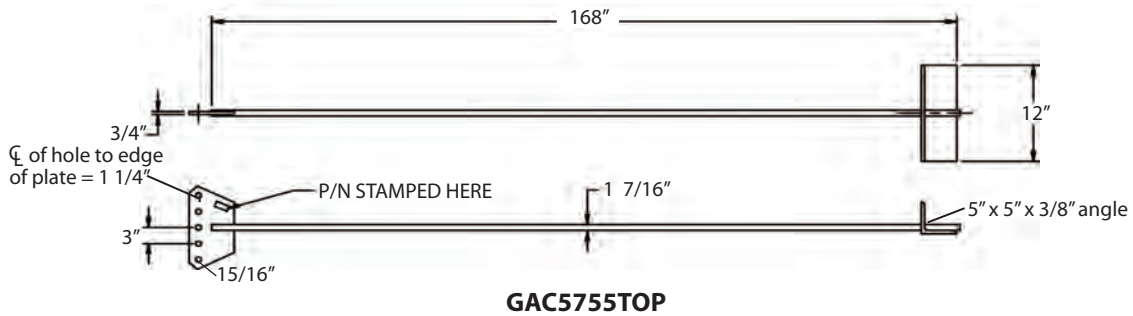
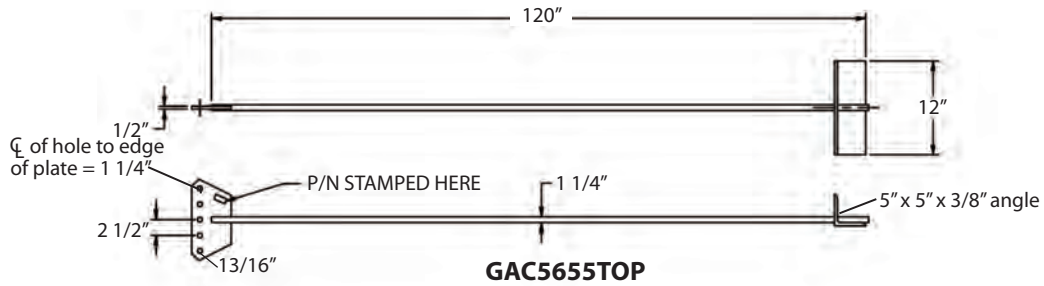
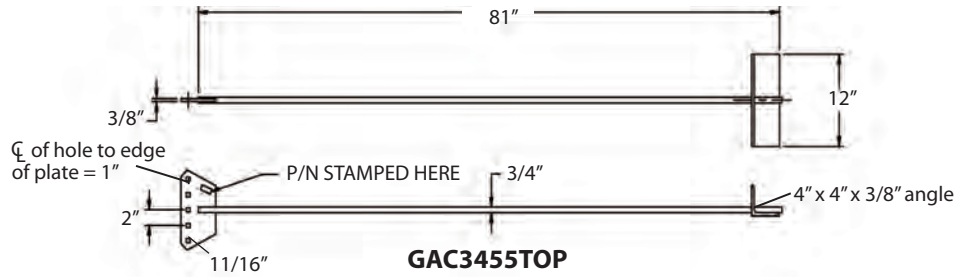

REV G
ANCHOR GROUNDING
AGK1GGX

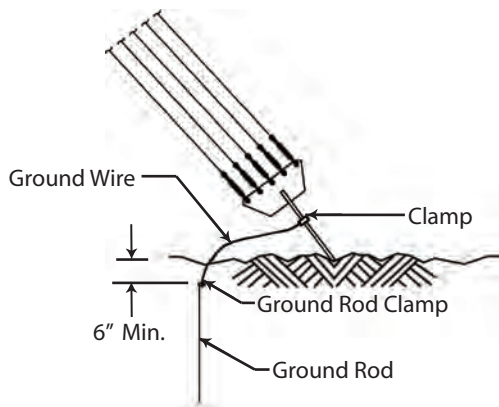

REV G
BASE GROUNDING
BGK3GGX

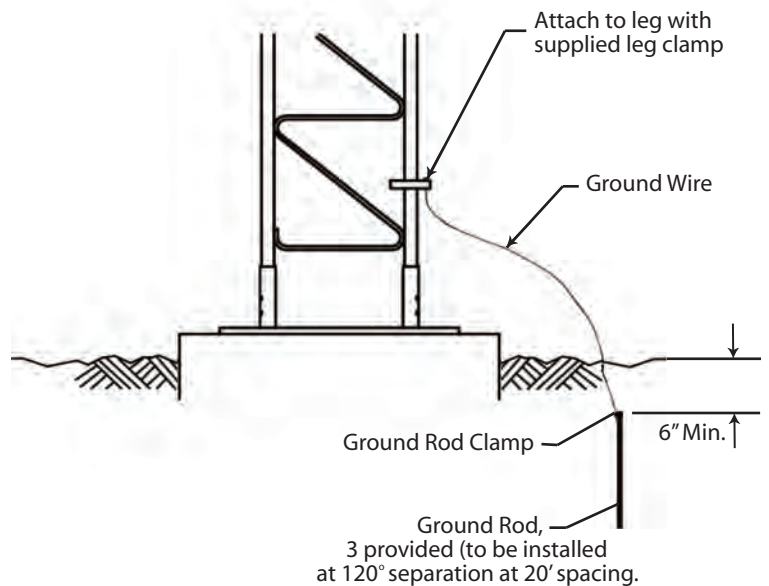

STANDARD ANCHOR BLOCKS

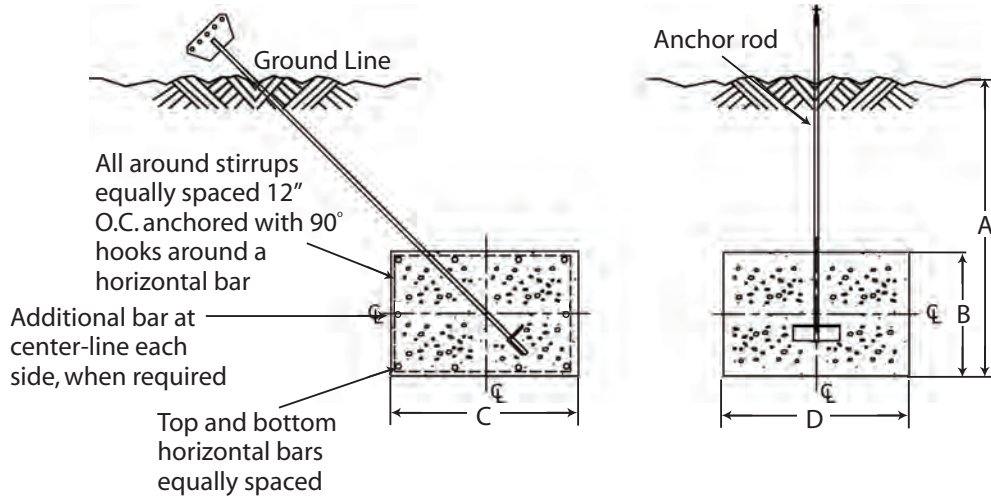

Refer to pages 95-96 for anchor rod installation angles.

Block	Anchor Dimensions (in.)				Horizontal Bars (Qty. & Size)	Stirrup Size & Spacing	Concrete Vol. (Cu. Yds.)
	A	B	C	D			
AB2	4' - 0"	1' - 6"	4' - 0"	6' - 0"	(5) #6 Bars, Top Layer (5) #6 Bars, Bottom Layer (0) Additional Bar, Each Side	#3 @ 12" O.C.	1.33 Per Block 4.0 Total for 3
AB3	6' - 0"	1' - 6"	3' - 0"	6' - 0"	(4) #6 Bars, Top Layer (4) #6 Bars, Bottom Layer (0) Additional Bar, Each Side	#3 @ 12" O.C.	1.0 Per Block 3.0 Total for 3
AB4	6' - 0"	1' - 6"	4' - 0"	9' - 0"	(5) #6 Bars, Top Layer (5) #6 Bars, Bottom Layer (0) Additional Bar, Each Side	#4 @ 12" O.C.	2.0 Per Block 6.0 Total for 3
AB5	8' - 0"	2' - 0"	3' - 0"	10' - 0"	(4) #7 Bars, Top Layer (4) #7 Bars, Bottom Layer (1) Additional Bar, Each Side	#4 @ 12" O.C.	2.22 Per Block 6.7 Total for 3
AB6	8' - 0"	2' - 0"	4' - 0"	10' - 0"	(5) #7 Bars, Top Layer (5) #7 Bars, Bottom Layer (1) Additional Bar, Each Side	#4 @ 12" O.C.	2.96 Per Block 8.9 Total for 3



ANCHOR ROD INSTALLATION ANGLES

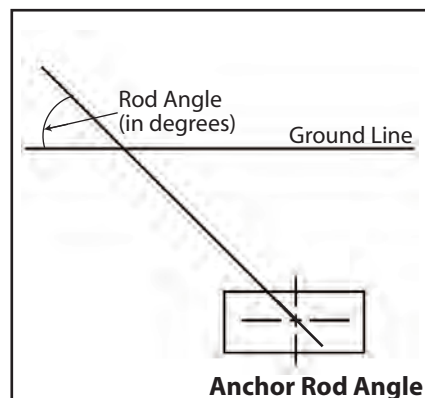
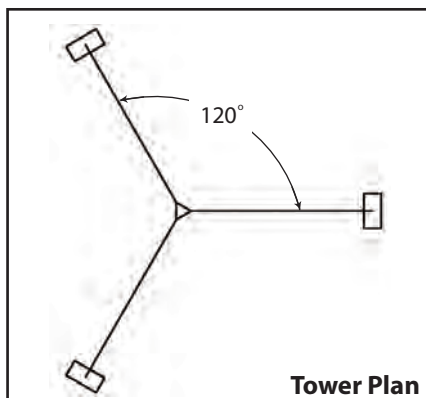

45GSR 90MPH				
Tower Height	Inner Rod Number	Inner Rod Angle	Outer Rod Number	Outer Rod Angle
40'	GAC3455TOP	48	-	-
50'	GAC3455TOP	49	-	-
60'	GAC3455TOP	49	-	-
70'	GAC3455TOP	44	-	-
80'	GAC3455TOP	43	-	-
90'	GAC3455TOP	44	-	-
100'	GAC3455TOP	44	-	-
110'	GAC3455TOP	42	-	-
120'	GAC3455TOP	42	-	-
130'	GAC3455TOP	42	-	-
140'	GAC3455TOP	42	-	-
150'	GAC3455TOP	40	-	-
160'	GAC3455TOP	40	-	-
170'	GAC5655TOP	40	-	-
180'	GAC5655TOP	41	-	-
190'	GAC5655TOP	40	-	-
200'	GAC5655TOP	40	-	-
220'	GAC5655TOP	40	-	-
240'	GAC3455TOP	38	GAC3455TOP	46
260'	GAC3455TOP	40	GAC3455TOP	46
280'	GAC3455TOP	38	GAC5655TOP	44
300'	GAC3455TOP	40	GAC5655TOP	44
320'	GAC3455TOP	37	GAC5655TOP	45
340'	GAC3455TOP	38	GAC5655TOP	45

45GSR 110MPH				
Tower Height	Inner Rod Number	Inner Rod Angle	Outer Rod Number	Outer Rod Angle
40'	GAC3455TOP	48	-	-
50'	GAC3455TOP	49	-	-
60'	GAC3455TOP	49	-	-
70'	GAC3455TOP	43	-	-
80'	GAC3455TOP	42	-	-
90'	GAC3455TOP	43	-	-
100'	GAC3455TOP	44	-	-
110'	GAC3455TOP	41	-	-
120'	GAC3455TOP	41	-	-
130'	GAC3455TOP	41	-	-
140'	GAC3455TOP	42	-	-
150'	GAC5655TOP	40	-	-
160'	GAC5655TOP	40	-	-
170'	GAC5655TOP	40	-	-
180'	GAC5655TOP	40	-	-
190'	GAC5655TOP	40	-	-
200'	GAC5655TOP	40	-	-
220'	GAC5655TOP	40	-	-
240'	GAC3455TOP	39	GAC5655TOP	45
260'	GAC3455TOP	40	GAC5655TOP	45
280'	GAC3455TOP	39	GAC5655TOP	43
300'	GAC3455TOP	40	GAC5655TOP	44
320'	GAC5655TOP	40	GAC5655TOP	44
340'	GAC5655TOP	40	GAC5655TOP	44

See the following page for 45GSR | 130mph anchor rod slopes.



ANCHOR ROD INSTALLATION ANGLES

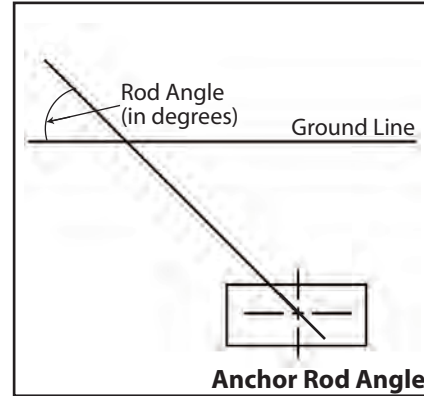
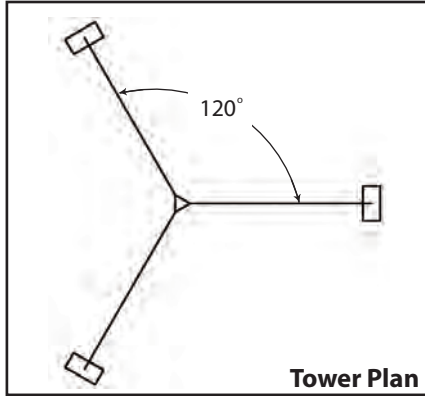

45GSR 130MPH				
Tower Height	Inner Rod Number	Inner Rod Angle	Outer Rod Number	Outer Rod Angle
40'	GAC3455TOP	48	-	-
50'	GAC3455TOP	48	-	-
60'	GAC3455TOP	45	-	-
70'	GAC3455TOP	42	-	-
80'	GAC3455TOP	42	-	-
90'	GAC3455TOP	43	-	-
100'	GAC3455TOP	43	-	-
110'	GAC5655TOP	40	-	-
120'	GAC5655TOP	40	-	-
130'	GAC5655TOP	41	-	-
140'	GAC5655TOP	41	-	-
150'	GAC5755TOP	39	-	-
160'	GAC5755TOP	38	-	-
170'	GAC5755TOP	39	-	-
180'	GAC5755TOP	39	-	-
190'	GAC5755TOP	37	-	-
200'	GAC5755TOP	38	-	-
220'	GAC5755TOP	38	-	-
240'	GAC5655TOP	40	GAC5655TOP	45
260'	GAC5655TOP	41	GAC5655TOP	45
280'	GAC5755TOP	38	GAC5755TOP	42
300'	GAC5755TOP	39	GAC5755TOP	43
320'	GAC5755TOP	37	GAC5655TOP	43
340'	GAC5755TOP	38	GAC5655TOP	43



STANDARD MAT FOUNDATION FOR 45GSR TOWERS

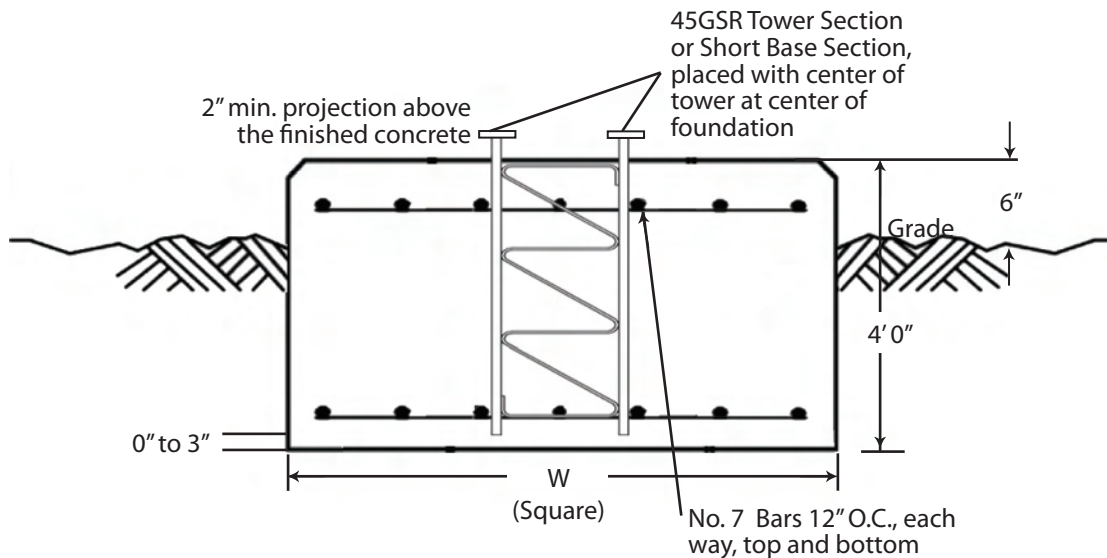

Base	Mat Width (W)	Concrete Vol. (Cu. Yds.)
FB1G	4' - 6"	3.0
FB2G	5' - 3"	4.1
FB3G	6' - 3"	5.8



STANDARD METEOROLOGICAL TOWERS

Complete Kit Includes:

- Assembly and foundation drawings
- All necessary tower sections
- Tower short base
- All guy wire and connectors
- All guy anchors
- Base and anchor grounding kits

60 m

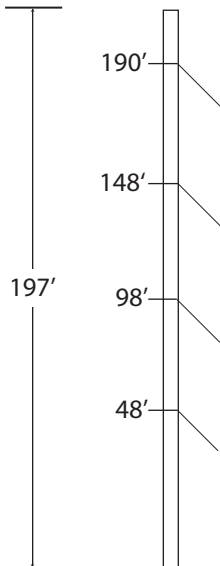

60MMET

- 4 Guy Elevations
- 1 Fixed Base Foundation
- 1 Anchor Radius

Boom Height	EPA / WT. (no ice)	EPA / WT. (3/4" radial ice)
40 m	9.00 sq. ft. / 200 lbs.	25.00 sq. ft. / 600 lbs.
50 m	9.00 sq. ft. / 200 lbs.	25.00 sq. ft. / 600 lbs.
60 m	9.00 sq. ft. / 200 lbs.	25.00 sq. ft. / 600 lbs.

ANSI/TIA-222-G
 110 MPH - 3 Second Gust (No Ice)
 50 MPH - 3 Second Gust (3/4" Radial Ice)
 Structure Class II
 Exposure Category C
 Topographic Category I

80 m

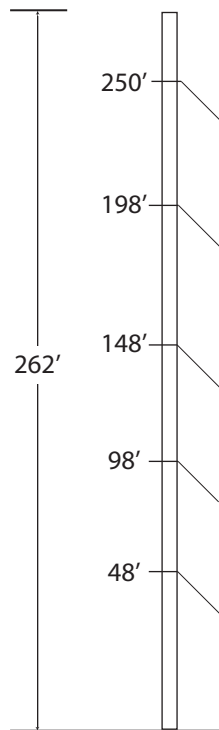

80MMET

- 5 Guy Elevations
- 1 Fixed Base Foundation
- 1 Anchor Radius

Boom Height	EPA / WT. (no ice)	EPA / WT. (3/4" radial ice)
60 m	9.00 sq. ft. / 200 lbs.	25.00 sq. ft. / 600 lbs.
70 m	9.00 sq. ft. / 200 lbs.	25.00 sq. ft. / 600 lbs.
80 m	9.00 sq. ft. / 200 lbs.	25.00 sq. ft. / 600 lbs.

ANSI/TIA-222-G
 110 MPH - 3 Second Gust (No Ice)
 50 MPH - 3 Second Gust (3/4" Radial Ice)
 Structure Class II
 Exposure Category C
 Topographic Category I

100 m

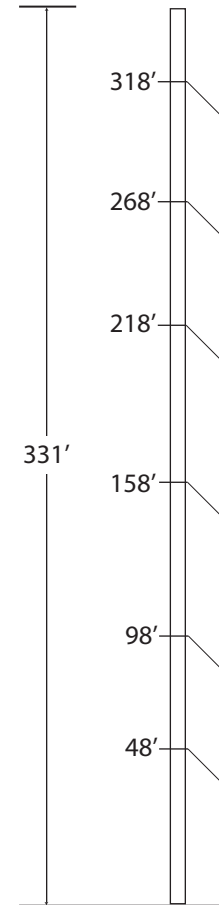

100MMET

- 6 Guy Elevations
- 1 Fixed Base Foundation
- 2 Anchor Radii

Boom Height	EPA / WT. (no ice)	EPA / WT. (3/4" radial ice)
50 m	9.00 sq. ft. / 200 lbs.	25.00 sq. ft. / 600 lbs.
75 m	9.00 sq. ft. / 200 lbs.	25.00 sq. ft. / 600 lbs.
100 m	9.00 sq. ft. / 200 lbs.	25.00 sq. ft. / 600 lbs.

ANSI/TIA-222-G
 110 MPH - 3 Second Gust (No Ice)
 50 MPH - 3 Second Gust (3/4" Radial Ice)
 Structure Class II
 Exposure Category C
 Topographic Category I

Tower design assumes (1) elevator track over height of structure.



STANDARD 45GSR METEOROLOGICAL TOWER

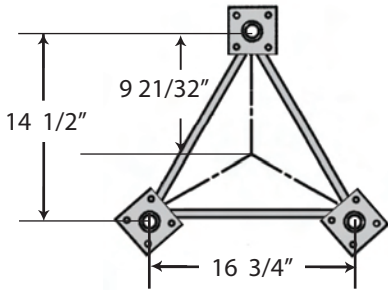

Tower Height (m)	Guy Radius (ft.) 120° separation	Base Foundation No.	Anchor Foundation No.
60	156	FB2G	AB4
80	210	FB3G	AB5
100	106 / 264	FB3G	AB2 / AB6

Refer to page 288 for anchor rod details.
FOR FOUNDATION INFORMATION, PLEASE SEE PAGES 94 & 97. FOR GENERAL INSTALLATION INFORMATION, PLEASE SEE PAGES 147-153.

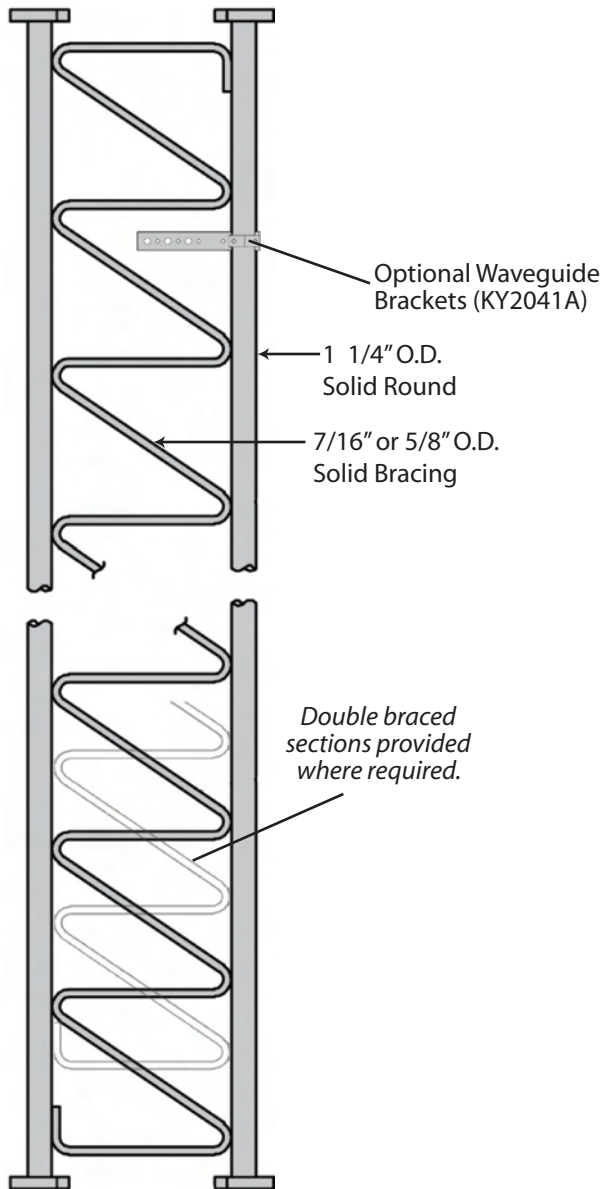

STANDARD SECTION
45GSR10 - 10' Section
45GSR20 - 20' Section

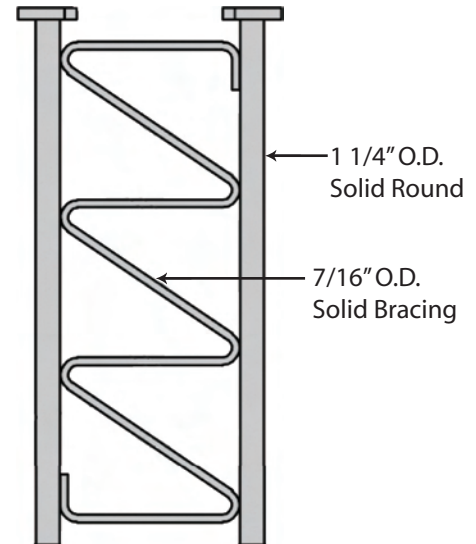

4.3' 45GSR SHORT BASE
45GSRSB

TO BE EMBEDDED IN CONCRETE.